

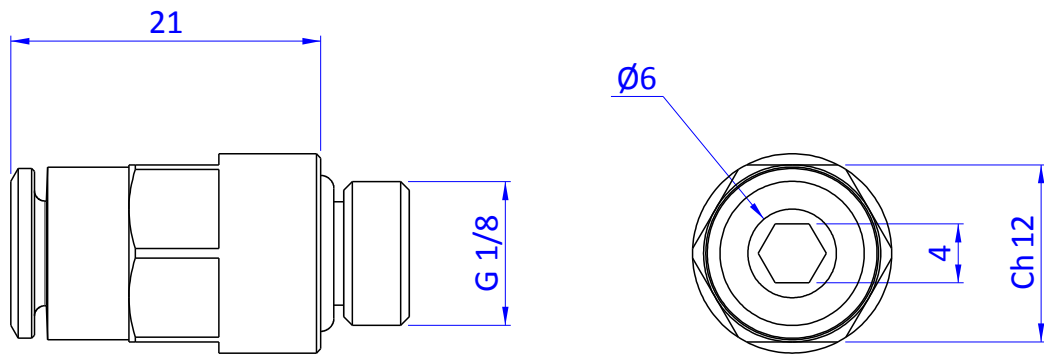

THE PROPERTY OF THE DRAWING IS ESTABLISHED BY LAW. IT IS FORBIDDEN TO PRODUCE OR SHOW IT TO THIRD PART. WITHOUT A WRITTEN AGREEMENT.

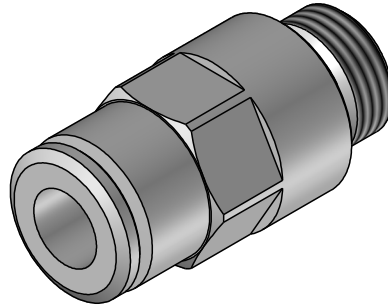
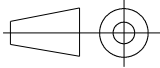

Format A4 UNI 936-76				DESIGNED FROM FPS Automation		REVIEW A
	GENERAL TOLERANCE UNI - ISO 2768 CLASSE f			DESCRIPTION CA.12.05.017	DATE 06/06/2019	WEIGHT 0.010Kg
					CODE CA.12.05.017	